

Form 18018
December, 1924
PRINTED IN U. S. A.

LIST OF PARTS



MACHINES

Nos. 119-2 and 119-3

THE SINGER MANUFACTURING COMPANY

From the library of: Diamond Needle Corp

COPYRIGHT, U. S. A., 1924,
BY THE SINGER MANUFACTURING CO.
ALL RIGHTS RESERVED FOR ALL COUNTRIES

INDEX

	PAGE
ACCESSORIES	19
BOBBIN WINDER	19
" " (SWINGING AUTOMATIC, RIGHT HAND)...	19
FOOT LIFTER PARTS	20
MACHINE No. 119-2	7
" " 119-3	13
NUMERICAL LIST OF PARTS	23
OBSOLETE PARTS	21

From the library of: Diamond Needle Corp

INSTRUCTIONS FOR ORDERING

In ordering from this list, use **ONLY** the **PART** number in the **FIRST** column.

The number stamped on a Sewing Machine part is in every case the number of the single part only.

Every combination of parts sent out as such has its specific number, which, although not stamped on the parts, must be used when ordering the combination.

Each number always indicates the **SAME PART** in whatever list it appears, or for whatever machine.

The letters after some of the numbers indicate the style of finish only, as follows:

- A. Hardened, Polished and Plated.
- B. Polished and Plated.
- C. Hardened only.
- D. Polished only.
- E. Soft, not Polished.
- F. Hardened and Polished.
- G.
- H. Blued.
- J. Plated only.
- K. Hardened and Plated.
- L. Brass or Gilt.
- M. Oxidized.
- P. Japanned.
- R. Parkerized.
- T. Copper-plated.

These letters **MUST BE USED** *when* they appear in the list, and **AFTER** the number *as* in the list.

In this series:

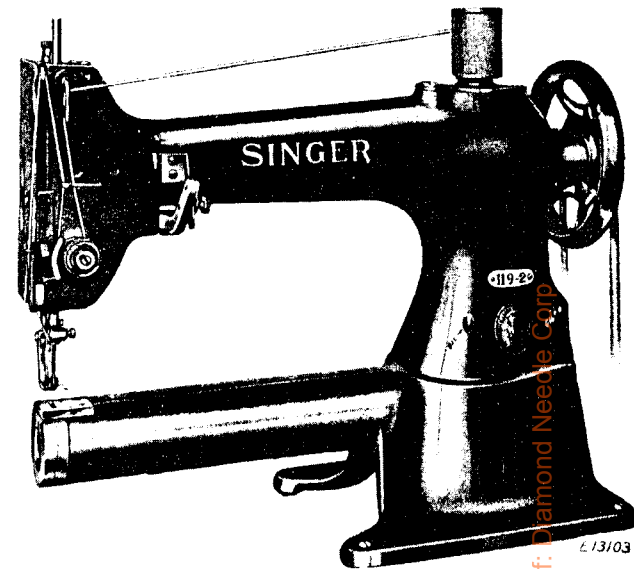
- 1, to 1500 and 50001 to 51500 are Screw Numbers.
- 1501 to 1800 are Nut Numbers.
- 1801 to 2000 are Roller Numbers.
- 2001 to 50000 and 52001 and upward are numbers of Machine Parts.

The figures in the second column refer only to the plates, illustrating the parts, and are **NOT TO BE USED** in ordering.

Parts marked with an asterisk (*) are furnished only when repairs are made at factory.

LIST OF PARTS COMPLETE

FOR



MACHINE No. 119-2

FOR GENERAL WORK ON BRIEF CASES AND OTHER LIGHT AND MEDIUM WEIGHT LEATHER AND FABRIC. COMBINED UPPER AND NEEDLE FEED, NO UNDER FEED.

NO.	PLATE	NAME
*37363	---	Arm.....
8582	6114	" Dowel Pin.....
11119	6114	" Oil Tube with 29599, for oiling 37343
12454	6114	" " " " " " 37344
29599	6114	" " " Packing (felt).....
116E	8851	" Screw (back).....
868E	8851	" " (front).....
37377	8852	" Shaft.....
12357	8853	" " Flanged Bushing (back).....
448c	8851	" " " " " " Set Screw.....

NO.	PLATE	NAME
37303	8853	Arm Shaft Flanged Bushing (front).....
430c	6112	“ “ “ “ “ Set
		Screw.....
141d	8851	Arm Shaft Screw.....
29505	8853	“ Top Cover.....
29505	8853	Arm Top Cover complete, Nos. 29505, 29507 and 29601.....
4430	6114	Arm Top Cover Friction Washer.....
79d	8851	“ “ “ Hinge Screw.....
29507	6114	“ “ “ Spool Pin and Thread
		Eyelet.....
29601	6114	Arm Top Cover Spool Pin and Thread
		Eyelet Washer (steel).....
11241	8860	Arm Top Cover Spool Pin and Thread
		Eyelet Washer (cloth).....
4370	8852	Balance Wheel (heavy rim) 2¾ in. pulley, with two 448c.....
448c	8851	Balance Wheel Set Screw.....
37859	8852	Cloth Plate.....
37860	8852	“ “ Bracket with 345c.....
345c	8851	“ “ “ Set Screw.....
389f	8851	“ “ “ Screw.....
37861	—	Cloth Plate with Bracket complete, Nos. 37859, 37860 and two 389f.....
20197	8853	Crank Connecting Rod with 20198 and two 896e.....
*20198	—	Crank Connecting Rod Cap.....
896e	8851	“ “ “ “ Screw.....
908c	8851	“ “ “ Hinge Screw.....
1619e	8851	“ “ “ “ “ Nut
*37851	—	Cylinder.....
37305	—	Face Plate with 37307.....
37306	8854	Face Plate complete, Nos. 2827 and 37305
219f	8851	“ “ “ Screw.....
2827	6114	“ “ “ Thread Guard (lower) with 8505.....
8505	6114	Face Plate Thread Guard (lower) Rivet..
37307	6114	“ “ “ “ (upper) with two 8505.....
8505	6114	Face Plate Thread Guard (upper) Rivet..
7299	8853	Feed Bar.....
37378	6103	“ “ Bell Crank.....
37379	6103	“ “ “ “ Bracket with 1497c.
1497c	6103	“ “ “ “ “ Set Screw..
212d	6103	“ “ “ “ “ Cap Screw.....
37310	6103	“ “ “ “ “ “ Washer..
15170	6103	“ “ “ “ “ Slide Block.....

NO.	PLATE	NAME
212d	6103	Feed Bar Bell Crank Slide Block Cap
		Screw.....
37364	6103	Feed Bar Guide Bracket.....
37365	—	“ “ “ “ “ Cap.....
37366	6103	“ “ “ “ “ “ 37365 with 37367.....
178f	6103	Feed Bar Guide Bracket Cap Screw.....
22372	6103	“ “ “ “ “ Slide Block.....
37367	—	“ “ “ “ “ “ “ 22372 with 37368.....
37368	6103	Feed Bar Guide Bracket Slide Block Stud
37314	6103	“ “ Socket Joint.....
37315	6103	“ “ “ “ “ Cap.....
178f	6103	“ “ “ “ “ “ Screw.....
37369	8853	“ Forked Connection.....
37317	6104	“ Regulator Crank with 1813.....
2049	6104	“ “ “ “ Pin.....
1813	6104	“ “ “ “ “ Roller and Stud..
37318	6104	“ “ “ Lever with 1057d.....
37319	—	“ “ “ “ 37318 with 330b and 37320.....
165d	6104	Feed Regulator Lever Cap Screw.....
37320	6104	“ “ “ “ Clamp.....
330b	6104	“ “ “ “ “ “ Screw.....
286d	6104	“ “ “ “ “ “ Thumb Screw
1057d	6104	“ “ “ “ “ Clamping Screw..
37370	6104	“ “ “ “ “ Segment.....
330b	6104	“ “ “ “ “ “ Screw.....
37322	6104	“ “ “ “ “ Shaft.....
18055	6114	Feeding Foot Hinge Pin.....
37356	—	“ “ “ Plate.....
37357	—	“ “ “ Shank.....
37358	8855	Feeding Foot (hinged) complete, Nos. 18055, 37356 and 37357.....
190d	8851	Feeding Foot Screw.....
6440	8856	Guide (roller) Nos. 1852 and 6441.....
6441	8856	“ Bracket.....
1852	8856	“ Roller and Screw Stud.....
161d	8856	“ Screw.....
37023	8853	Lifting Presser Bar (hollow).....
37327	6104	“ “ “ “ “ Connecting Link.....
212d	6103	“ “ “ “ “ “ “ Cap Screw.....
37310	6103	Lifting Presser Bar Connecting Link Cap Screw Washer.....
37380	6104	Lifting Presser Bar Lifter.....
17542	6104	“ “ “ “ “ “ Hinge Pin.....

From the Library of Almond Needle Corp.

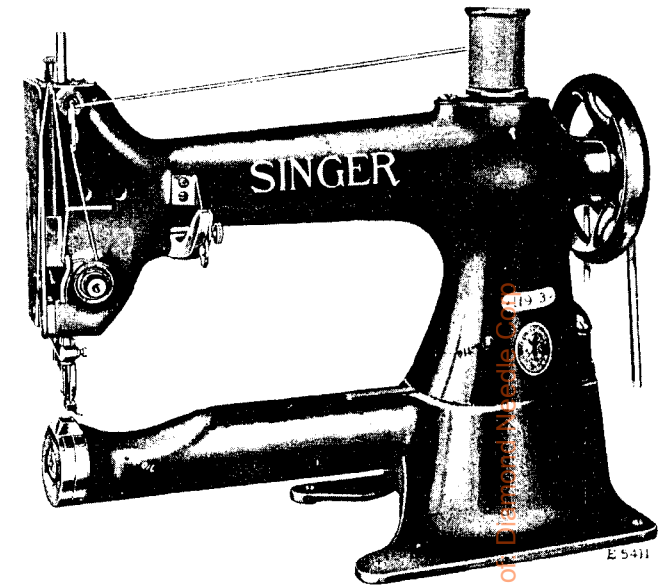
NO.	PLATE	NAME
37328	6104	Lifting Presser Bar Lifting Bracket with 453c.....
453c	6104	Lifting Presser Bar Lifting Bracket Set Screw.....
37408	8853	Lifting Presser Bar Spring.....
37025	6114	" " " " Pin.....
37329	8855	" " Foot (single).....
190D	8851	" " " Screw.....
5681	8853	Needle Bar.....
*37331	6112	" " Connecting Link with 794E.....
794E	6112	" " " " Adjusting Screw.....
775E	6112	Needle Bar Connecting Link Cap Screw.....
37332	6112	" " " Stud with 155c.....
37348	-----	" " " " 37332 with 212D and 15170.....
155c	6112	Needle Bar Connecting Stud Set Screw.....
37333	8853	" " Crank and Feed Cam with 858c and 1065c.....
1065c	8858	Needle Bar Crank and Feed Cam Position Screw.....
858c	8858	Needle Bar Crank and Feed Cam Set Screw.....
4302	6114	Needle Bar Thread Guard.....
233D	6114	" " " " Screw.....
4303	6114	" Clamp with 808F.....
808F	6114	" " Screw.....
37852	8855	" Plate with 1161D and 37853.....
175D	8855	" " Screw.....
37853	8855	" " Thread Guard.....
1161D	8855	" " " " Screw.....
*24104	8853	Oscillating Rock Shaft.....
24105	-----	Oscillating Rock Shaft complete, Nos. 4784, 12388 and 24104.....
12388	8853	Oscillating Rock Shaft Hinge Pin.....
878J	8851	" " " " " Oil Hole Stop Screw.....
12459	6114	Oscillating Rock Shaft Hinge Pin Oil Hole Stop Screw Washer (leather).....
448c	8851	Oscillating Rock Shaft Hinge Pin Set Screw.....
4784	6114	Oscillating Rock Shaft Oil Pad.....
12389	8852	" Shaft.....
37385	-----	" " Crank.....
37386	8856	Oscillating Shaft Crank complete, Nos. 457c, 1518E, 19449 and 37385.....

NO.	PLATE	NAME
2049	6104	Oscillating Shaft Crank Pin.....
457c	8856	" " " Set Screw.....
19448	8856	" " " Slide Block.....
226D	8856	" " " " " Cap Screw.....
12424	8856	Oscillating Shaft Crank Slide Block Cap Screw Washer.....
988c	8856	Oscillating Shaft Crank Slide Block Screw Stud.....
1518E	8856	Oscillating Shaft Crank Slide Block Screw Stud Nut.....
19449	-----	Oscillating Shaft Crank Slide Block complete, Nos. 226D, 988c, 12424 and 19448.....
1210E	8851	Pressure Regulating Thumb Screw.....
2996	8856	Shuttle Bobbin.....
224840	-----	" " Case.....
15140	8856	" " " Latch.....
2973	8856	" " " Lever.....
2974	8856	" " " " Fulcrum Pin.....
2975	8856	Shuttle Bobbin Case Latch Spring.....
592E	8856	" " " " Stop Screw.....
15141	-----	Shuttle Bobbin Case Hinge, Nos. 2973, 2974 and 15140.....
7553	8856	Shuttle Bobbin Case Position Finger.....
2523	8856	" " " " Rivet.....
224841	8856	Shuttle Bobbin Case complete, Nos. 591F, 592E, 2523, 2975, 7553, 15141, 224840 and 224842.....
37854	8856	Shuttle Body.....
591F	8856	" Tension Regulating Screw.....
224842	8856	" " Spring.....
37855	-----	Shuttle, 1 1/8 in. diam., Nos. 2996, 37854 and 224841.....
*37371	-----	Shuttle Driver.....
37372	8856	" " 37371 with two 462c.....
2049	6104	" " Pin.....
462c	8856	" " Set Screw.....
37876	-----	" Race Body.....
37877	-----	" " Ring.....
18413	8857	" " " Spring.....
1289D	8857	" " " Screw.....
37878	8857	Shuttle Race (flexible) complete, Nos. 37876, 37877 and two each 1289D and 18413.....
171E	8857	Shuttle Race Screw.....

NO.	PLATE	NAME
2102	8858	Tension Disc.....
1560c	8858	" Regulating Thumb Nut.....
32572	8858	" Releasing Disc.....
37375	8858	" " Lever.....
37387	8858	" " " Connection.....
37388	8858	" " " " Extension.....
190b	8851	Tension Releasing Lever Connection Extension Screw.....
7071	8858	Tension Releasing Lever Connection Extension Screw Washer.....
8285	8858	Tension Releasing Lever Hinge Pin.....
24143	8858	" " " Spring.....
32574	8858	" " Pin.....
1274c	8858	" Screw Stud.....
2103	8858	" Spring.....
12149	8858	" Thread Guard.....
37404	---	Tension complete, Nos. 1274c, 1560c, 2103, 8511, 32572, 32574, 37351 and two 2102.....
24078	8858	Thread Guard (side of arm).....
52454	8858	" Retainer.....
50429c	8858	" " Set Screw.....
37389	6112	" Take-up Crank.....
3094	6112	" " " Wedge.....
690e	6112	" " " " Screw.....
37343	6112	" " Lever.....
12166	6112	" " " Hinge Pin.....
37344	6112	" " " Link.....
11204	6112	" " " " Hinge Pin.....
430c	6112	" " " " " " Set Screw.....
37345	---	Thread Take-up Lever complete, Nos. 12166, 37343 and 37344.....
8511	8858	Thread Take-up Spring.....
37351	8858	" " " Regulator.....
446c	8858	" " " " Set Screw.....

LIST OF PARTS COMPLETE

FOR



MACHINE No. 119-3

FOR STITCHING STRAPS ON WOMEN'S SHOES, SOLES ON INFANTS' SHOES AND WORK OF A SIMILAR NATURE. COMBINED UPPER AND NEEDLE FEED, NO UNDER FEED. THE NEEDLE PLATE IS RAISED AND CLEARANCE IS MADE ON THE TOP OF THE CYLINDER FOR CONVENIENCE IN HANDLING THE WORK.

NO.	PLATE	NAME
*37363	---	Arm.....
8582	6114	" Dowel Pin.....
11119	6114	" Oil Tube with 29599, for oiling 37343
12454	6114	" " " " " " 37344
29599	6114	" " " Packing (felt).....
116E	8851	" Screw (back).....
868E	8851	" " (front).....
37377	8852	" Shaft.....

NO.	PLATE	NAME
12357	8853	Arm Shaft Flanged Bushing (back).....
448c	8851	“ “ “ “ “ Set
		Screw.....
37303	8853	Arm Shaft Flanged Bushing (front).....
430c	6112	“ “ “ “ “ Set
		Screw.....
144D	8851	Arm Shaft Screw.....
29505	8853	“ Top Cover.....
29506	8853	Arm Top Cover complete, Nos. 29505, 29507 and 29601.....
4430	6114	Arm Top Cover Friction Washer.....
79D	8851	“ “ “ Hinge Screw.....
29507	6114	“ “ “ Spool Pin and Thread Eyelet.....
29601	6114	Arm Top Cover Spool Pin and Thread Eyelet Washer (steel).....
11241	8860	Arm Top Cover Spool Pin and Thread Eyelet Washer (cloth).....
4370	8852	Balance Wheel (heavy rim) 2¾ in. pulley, with two 448c.....
448c	8851	Balance Wheel Set Screw.....
20197	8853	Crank Connecting Rod with 20198 and two 896E.....
*20198	—	Crank Connecting Rod Cap.....
896E	8851	“ “ “ “ “ Screw.....
908c	8851	“ “ “ “ Hinge Screw.....
1619E	8851	“ “ “ “ “ Nut.....
*37862	—	Cylinder.....
37305	—	Face Plate with 37307.....
37306	8854	Face Plate complete, Nos. 2827 and 37305
219F	8851	“ “ “ Screw.....
2827	6114	“ “ “ Thread Guard (lower) with 8505.....
8505	6114	Face Plate Thread Guard (lower) Rivet..
37307	6114	“ “ “ “ (upper) with two 8505.....
8505	6114	Face Plate Thread Guard (upper) Rivet
7299	8853	Feed Bar.....
37378	6103	“ “ “ Bell Crank.....
37379	6103	“ “ “ “ Bracket with 1497c.
1497c	6103	“ “ “ “ “ Set Screw..
212D	6103	“ “ “ “ “ Cap Screw.....
37310	6103	“ “ “ “ “ Washer..
15170	6103	“ “ “ “ “ Slide Block.....
212D	6103	“ “ “ “ “ “ Cap Screw
37364	6103	“ “ “ Guide Bracket.....
37365	—	“ “ “ “ “ Cap.....

NO.	PLATE	NAME
37366	6103	Feed Bar Guide Bracket Cap 37365 with 37367.....
178F	6103	Feed Bar Guide Bracket Cap Screw.....
22372	6103	“ “ “ “ “ Slide Block.....
37367	—	“ “ “ “ “ “ 22372 with 37368.....
37368	6103	Feed Bar Guide Bracket Slide Block Stud
37314	6103	“ “ “ Socket Joint.....
37315	6103	“ “ “ “ “ Cap.....
178F	6103	“ “ “ “ “ “ Screw.....
37369	8853	“ Forked Connection.....
37317	6104	“ Regulator Crank with 1813.....
2049	6104	“ “ “ Pin.....
1813	6104	“ “ “ Roller and Stud...
37318	6104	“ “ “ Lever with 1057D.....
37319	—	“ “ “ “ 37318 with 330D and 37320.....
165D	6104	Feed Regulator Lever Cap Screw.....
37320	6104	“ “ “ “ Clamp.....
330D	6104	“ “ “ “ “ Screw.....
286D	6104	“ “ “ “ “ Thumb Screw
1057D	6104	“ “ “ “ Clamping Screw.....
37370	6104	“ “ “ “ “ Segment.....
330D	6104	“ “ “ “ “ “ Screw.....
37322	6104	“ “ “ “ “ Shaft.....
217F	8851	“ “ “ “ “ Stop Screw, for in- fants' shoes.....
1580E	8851	Feed Regulator Lever Stop Screw Nut, for infants' shoes.....
37863	8855	Feeding Foot.....
37873	8855	“ “ “ for stitching back straps on ladies' shoes.....
190D	8851	Feeding Foot Screw.....
37023	8853	Lifting Presser Bar (hollow).....
37327	6104	“ “ “ “ “ Connecting Link.....
212D	6103	“ “ “ “ “ “ Cap Screw.....
37310	6103	Lifting Presser Bar Connecting Link Cap Screw Washer.....
37380	6104	Lifting Presser Bar Lifter.....
17542	6104	“ “ “ “ “ Hinge Pin.....
37328	6104	“ “ “ “ “ Lifting Bracket with 453c.....
453c	6104	Lifting Presser Bar Lifting Bracket Set Screw.....
37408	8853	Lifting Presser Bar Spring.....
37025	6114	“ “ “ “ “ Pin.....

From the library of: Diamond Leede Co.

NO.	PLATE	NAME
37864	8855	Lifting Presser Foot.....
37874	8855	“ “ “ for stitching back strap on ladies' shoes.....
37865	8855	Lifting Presser Foot, for infants' shoes....
190d	8851	“ “ “ Screw.....
5681	8853	Needle Bar.....
*37331	6112	“ “ Connecting Link with 794E..
794E	6112	“ “ “ “ Adjusting Screw.....
775E	6112	Needle Bar Connecting Link Cap Screw.
37332	6112	“ “ “ Stud with 155c...
37348	-----	“ “ “ “ 37332 with 212d and 15170.....
155c	6112	Needle Bar Connecting Stud Set Screw...
37333	8853	“ “ Crank and Feed Cam with 858c and 1065c.....
1065c	8858	Needle Bar Crank and Feed Cam Position Screw.....
858c	8858	Needle Bar Crank and Feed Cam Set Screw.....
4302	6114	Needle Bar Thread Guard.....
233d	6114	“ “ “ “ Screw.....
4303	6114	“ Clamp with 808F.....
808F	6114	“ “ Screw.....
37866	8855	Needle Plate (large needle hole) with 1161d and 37868.....
37867	-----	Needle Plate (small needle hole) with 1161d and 37868.....
37875	-----	Needle Plate (short needle hole) with 1161d and 37868, for stitching back strap on ladies' shoes.....
393d	8855	Needle Plate Screw.....
37868	8855	“ “ Thread Guard.....
1161d	8855	“ “ “ “ Screw.....
*24104	8853	Oscillating Rock Shaft.....
24105	-----	Oscillating Rock Shaft complete, Nos. 4784, 12388 and 24104.....
12388	8853	Oscillating Rock Shaft Hinge Pin.....
878j	8851	“ “ “ “ “ Oil Hole Stop Screw.....
12459	6114	Oscillating Rock Shaft Hinge Pin Oil Hole Stop Screw Washer (leather).....
448c	8851	Oscillating Rock Shaft Hinge Pin Set Screw.....
4784	6114	Oscillating Rock Shaft Oil Pad.....
12389	8852	“ Shaft.....
37385	-----	“ “ Crank.....

NO.	PLATE	NAME
37385	8856	Oscillating Shaft Crank complete, Nos. 457c, 1518E, 19449 and 37385.....
2049	6104	Oscillating Shaft Crank Pin.....
457c	8856	“ “ “ Set Screw.....
19448	8856	“ “ “ Slide Block.....
226d	8856	“ “ “ “ “ C a p Screw.....
12424	8856	Oscillating Shaft Crank Slide Block Cap Screw Washer.....
988c	8856	Oscillating Shaft Crank Slide Block Screw Stud.....
1518E	8856	Oscillating Shaft Crank Slide Block Screw Stud Nut.....
19449	-----	Oscillating Shaft Crank Slide Block com- plete, Nos. 226d, 988c, 12424 and 19448
1210E	8851	Pressure Regulating Thumb Screw.....
2096	8856	Shuttle Bobbin.....
224840	-----	“ “ Case.....
15140	8856	“ “ “ Latch.....
2973	8856	“ “ “ “ Lever.....
2974	8856	“ “ “ “ “ Fullerum Pin.....
2975	8856	Shuttle Bobbin Case Latch Spring.....
592E	8856	“ “ “ “ Stop Screw..
15141	-----	Shuttle Bobbin Case Hinge, Nos. 2973, 2974 and 15140.....
7553	8856	Shuttle Bobbin Case Position Finger.....
2523	8856	“ “ “ “ “ Rivet
224841	8856	Shuttle Bobbin Case complete, Nos. 591E, 592E, 2523, 2975, 7553, 15141, 224840 and 224842.....
37854	8856	Shuttle Body.....
591E	8856	“ Tension Regulating Screw.....
224842	8856	“ “ Spring.....
37855	-----	Shuttle, 1 1/8 in. diam., Nos. 2993, 37854 and 224841.....
*37371	-----	Shuttle Driver.....
37372	8856	“ “ 37371 with two 462c.....
2049	6104	“ “ Pin.....
462c	8856	“ “ Set Screw.....
7869	-----	“ Race Body.....
37870	-----	“ “ Ring.....
18413	8857	“ “ “ Spring.....
1289b	8857	“ “ “ “ Screw.....
37871	8857	Shuttle Race (flexible) complete, Nos. 37869, 37870 and two each 1289b and 18413.....

NO.	PLATE	NAME
37879	---	Shuttle Race 37871 with 37866 and two 393d
37880	---	Shuttle Race 37871 with 37867 and two 393d
37881	---	Shuttle Race 37871 with 37875 and two 393d, for stitching back strap on ladies' shoes
171E	8857	Shuttle Race Screw
2102	8858	Tension Disc
1560c	8858	" Regulating Thumb Nut
32572	8858	" Releasing Disc
37375	8858	" " Lever
37387	8858	" " " Connection
37388	8858	" " " " Ex-tension
190d	8851	Tension Releasing Lever Connection Ex-tension Screw
7071	8858	Tension Releasing Lever Connection Ex-tension Screw Washer
8285	8858	Tension Releasing Lever Hinge Pin
24143	8858	" " " Spring
32574	8858	" " Pin
1274c	8858	" Screw Stud
2103	8858	" Spring
12149	8858	" Thread Guard
37404	---	Tension complete, Nos. 1274c, 1560c, 2103, 8511, 32572, 32574, 37351 and two 2102
24078	8858	Thread Guard (side of arm)
52454	8858	" Retainer
50429c	8858	" " Set Screw
37389	6112	" Take-up Crank
3094	6112	" " " Wedge
690E	6112	" " " " Screw
37343	6112	" " Lever
12166	6112	" " " Hinge Pin
37344	6112	" " " Link
11204	6112	" " " " Hinge Pin
430c	6112	" " " " " " Set Screw
37345	---	Thread Take-up Lever complete, Nos. 12166, 37343 and 37344
8511	8858	Thread Take-up Spring
37351	8858	" " " Regulator
446c	8858	" " " " Set Screw

ACCESSORIES

NO.	PLATE	NAME
599E	8851	Machine Bolt with 1524E, to secure machine to table
1524E	8851	Machine Bolt Nut
6055	8851	" " " Washer
120342	6120	Oiler (copper-plated) with 120343
120343	6120	" Spout, 3½ in. long
26026	6120	Screw Driver (machine)
26485	6120	" " (shuttle tension)
8909	6120	Wrench for 1518
19221	6120	" " 1619

BOBBIN WINDER

NO.	PLATE	NAME
15072	6114	Bobbin Position Pin
12168	8854	Bracket
692d	8851	" Screw
12169	8859	Frame
12171	---	Frame complete, Nos. 333d, 5960, 5961, 5963, 12169 and 15077
32d	8859	Frame Hinge Screw
5960	8859	Friction Wheel (leather)
5961	8859	" " Washer
333d	8859	" " " Screw
15077	8859	Spindle with 15072
5963	8859	" Flange
12170	8859	Spring
180f	8859	" Screw
12172	---	Bobbin Winder complete, Nos. 32d, 180f, 12168, 12170 and 12171

BOBBIN WINDER

(Swinging Automatic, Right Hand)

FOR POWER TABLE

NO.	PLATE	NAME
27552	8854	Base
15072	6114	Bobbin Position Pin
27302	8854	Frame
50356d	8860	" Hinge Screw
1620j	8860	" " " Nut
27303	6114	" Spring

From the library of: Diamond Needle Corp

NO.	PLATE	NAME
27553	8854	Pulley.....
27849	—	Spindle.....
27538	8854	" 27849 with 15072, 27850 and 41828.....
*27850	—	Spindle Collar.....
41828	—	" " Pin.....
27306	8860	Spool Pin.....
27307	8854	" Stand.....
27308	8854	Spool Stand complete, Nos. 418E, 1562J, 2106, 10141, 11241, 27306, 27307 and two each 2455 and wood screws 1 in. No. 10.....
11241	8860	Spool Washer (cloth).....
27312	8860	Stop Latch.....
35D	8860	" " Hinge Screw.....
2455	6114	Tension Disc.....
1562J	6114	" Regulating Thumb Nut.....
418E	6114	" Screw Stud.....
10141	6114	" Spring.....
2106	6114	" Thread Guide.....
27650	—	Bobbin Winder, Nos. 35D, 1620J, 27302, 27303, 27312, 27538, 27552, 27553, 50356D and two wood screws 1 in. No. 7.....
27554	—	Bobbin Winder (swinging automatic, right hand) complete, Nos. 27308 and 27650.....

FOOT LIFTER PARTS

NO.	PLATE	NAME
6439	—	Chain, length 36 in. to 45 in., with 56864 and 56865.....

NOTE: When ordering No. 6439 state length required.

4879	8860	Chain Connecting Link.....
56864	8860	" Hook (large).....
56865	8860	" " (small).....
37346	8852	Lifting Lever with 453c.....
802D	8851	" " Hinge Screw.....
37390	8860	" " Link.....
766D	8860	" " " Hinge Screw.....
4727	3860	" " Pin.....
453c	6104	" " " Set Screw.....
4881	8852	Treadle.....
4882	8854	" Shaft.....
4883	8854	" Spring.....
4884	8852	" Stand.....

NO.	PLATE	NAME
4885	8852	Treadle complete, Nos. 4879, 4881 to 4884 and two wood screws 1 in. No. 16.....
37872	—	Foot Lifter complete, Nos. 766D, 802D, 4727, 4885, 6439, 37346 and 37390....

OBSOLETE PARTS

NO.	PLATE	NAME
37856	—	Shuttle Race Body for 37858.....
37857	—	" " Ring for 37858.....
37858	—	Shuttle Race (flexible) complete for 119-2 Machine, Nos. 37856, 37857 and two each 1289D and 18413, use 37878..

NUMERICAL
LIST
OF PARTS

NUMERICAL LIST OF PARTS

NO. PLATE	NAME
32D 8859	Bobbin Winder Frame Hinge Screw for 12172.....
35D 8860	Bobbin Winder Stop Latch Hinge Screw for 27650.....
79D 8851	Arm Top Cover Hinge Screw.....
116E 8851	" Screw (back).....
144D 8851	" Shaft Screw.....
155c 6112	Needle Bar Connecting Stud Set Screw for 37332.....
161D 8856	Guide Screw for 119-2 Machine.....
165D 6104	Feed Regulator Lever Cap Screw.....
171E 8857	Shuttle Race Screw.....
175D 8855	Needle Plate Screw for 119-2 Machine...
178F 6103	Feed Bar Guide Bracket Cap Screw.....
178F 6103	" " Socket Joint Cap Screw.....
180F 8859	Bobbin Winder Spring Screw for 2172...
190D 8851	Feeding Foot Screw.....
190D 8851	Lifting Presser Foot Screw.....
190D 8851	Tension Releasing Lever Connection Extension Screw.....
212D 6103	Feed Bar Bell Crank Cap Screw.....
212D 6103	" " " " Slide Block Cap Screw for 37348.....
212D 6103	Lifting Presser Bar Connecting Link Cap Screw.....
217F 8851	Feed Regulator Lever Stop Screw, for infants' shoes, for 119-3 Machine....
219F 8851	Face Plate Screw.....
226D 8856	Oscillating Shaft Crank Slide Block Cap Screw for 19449.....
233D 6114	Needle Bar Thread Guard Screw.....
286D 6104	Feed Regulator Lever Clamp Thumb Screw.....
330D 6104	Feed Regulator Lever Clamp Screw for 37319.....
330D 6104	Feed Regulator Lever Segment Screw...
333D 8859	Bobbin Winder Friction Wheel Washer Screw for 12171.....
345c 8851	Cloth Plate Bracket Set Screw for 37860
389F 8851	" " Screw for 37861.....
393D 8855	Needle Plate Screw for 37879 to 37881..
418E 6114	Bobbin Winder Tension Screw Stud for 27308.....

NO.	PLATE	NAME
430c	6112	Arm Shaft Flanged Bushing (front) Set Screw.....
430c	6112	Thread Take-up Lever Link Hinge Pin Set Screw.....
446c	8858	Thread Take-up Spring Regulator Set Screw.....
448c	8851	Arm Shaft Flanged Bushing (back) Set Screw.....
448c	8851	Balance Wheel Set Screw for 4370.....
448c	8851	Oscillating Rock Shaft Hinge Pin Set Screw.....
453c	6104	Lifting Lever Pin Set Screw for 37346.....
453c	6104	" Presser Bar Lifting Bracket Set Screw for 37328.....
457c	8856	Oscillating Shaft Crank Set Screw for 37386.....
462c	8856	Shuttle Driver Set Screw for 37372.....
591F	8856	" Tension Regulating Screw for 224841.....
592E	8856	Shuttle Bobbin Case Latch Stop Screw for 224841.....
599E	8851	Machine Bolt with 1524E, to secure machine to table (Accessories).....
690E	6112	Thread Take-up Crank Wedge Screw.....
692D	8851	Bobbin Winder Bracket Screw for 12168.....
766D	8860	Lifting Lever Link Hinge Screw for 37872.....
775E	6112	Needle Bar Connecting Link Cap Screw.....
794E	6112	" " " " Adjusting Screw for 37331.....
802D	8851	Lifting Lever Hinge Screw for 37872.....
808F	6114	Needle Clamp Screw for 4303.....
858c	8858	" Bar Crank and Feed Cam Set Screw for 37333.....
868E	8851	Arm Screw (front).....
878J	8851	Oscillating Rock Shaft Hinge Pin Oil Hole Stop Screw.....
896E	8851	Crank Connecting Rod Cap Screw for 20197.....
908c	8851	Crank Connecting Rod Hinge Screw.....
988c	8856	Oscillating Shaft Crank Slide Block Screw Stud for 19449.....
1057D	6104	Feed Regulator Lever Clamping Screw for 37318.....
1065c	8858	Needle Bar Crank and Feed Cam Position Screw for 37333.....
1161D	8855	Needle Plate Thread Guard Screw for 37852, 37866, 37867 and 37875.....

NO.	PLATE	NAME
1210E	8851	Pressure Regulating Thumb Screw.....
1274c	8858	Tension Screw Stud for 37404.....
1289D	8857	Shuttle Race Ring Spring Screw for 37858, 37871 and 37878.....
1497c	6103	Feed Bar Bell Crank Bracket Set Screw for 37379.....
1518E	8856	Oscillating Shaft Crank Slide Block Screw Stud Nut for 37386.....
1524E	8851	Machine Bolt Nut for 599E.....
1560c	8858	Tension Regulating Thumb Nut for 37404.....
1562J	6114	Bobbin Winder Tension Regulating Thumb Nut for 27308.....
1580E	8851	Feed Regulator Lever Stop Screw Nut, for infants' shoes, for 119-3 Machine..
1619E	8851	Crank Connecting Rod Hinge Screw Nut
1620J	8860	Bobbin Winder Frame Hinge Screw Nut for 27650.....
1813	6104	Feed Regulator Crank Roller and Stud for 37317.....
1852	8856	Guide Roller and Screw Stud for 6440..
2049	6104	Feed Regulator Crank Pin.....
2049	6104	Oscillating Shaft Crank Pin.....
2049	6104	Shuttle Driver Pin.....
2102	8858	Tension Disc for 37404.....
2103	8858	" Spring for 37404.....
2106	6114	Bobbin Winder Tension Thread Guide for 27308.....
2455	6114	Bobbin Winder Tension Disc for 27308..
2523	8856	Shuttle Bobbin Case Position Finger Rivet for 224841.....
2827	6114	Face Plate Thread Guard (lower) with 8505, for 37306.....
2973	8856	Shuttle Bobbin Case Latch Lever for 15141.....
2974	8856	Shuttle Bobbin Case Latch Lever Fulcrum Pin for 15141.....
2975	8856	Shuttle Bobbin Case Latch Spring for 224841.....
2996	8856	Shuttle Bobbin for 37855.....
3094	6112	Thread Take-up Crank Wedge.....
4302	6114	Needle Bar Thread Guard.....
4303	6114	" Clamp with 808F.....
4370	8852	Balance Wheel (heavy rim, 2¾ in. pulley, with two 448c.....
4430	6114	Arm Top Cover Friction Washer.....
4727	8860	Lifting Lever Pin for 37872.....
4784	6114	Oscillating Rock Shaft Oil Pad for 24105

From the library of Diamond Needle Corp.

NO.	PLATE	NAME
4879	8860	Chain Connecting Link for 4885.....
		Nos. 4881 to 4884 FOR 4885
4881	8852	Treadle.....
4882	8854	“ Shaft.....
4883	8854	“ Spring.....
4884	8852	“ Stand.....
4885	8852	Treadle complete for 37872, Nos. 4879, 4881 to 4884 and two wood screws 1 in. No. 16.....
5681	8853	Needle Bar.....
5960	8859	Bobbin Winder Friction Wheel (leather) for 12171.....
5961	8859	Bobbin Winder Friction Wheel Washer for 12171.....
5963	8859	Bobbin Winder Spindle Flange for 12171.
6055	8851	Machine Bolt Nut Washer (Accessories)
6439	—	Chain, length 36 in. to 45 in., with 56864 and 56865, for 37872.....
6440	8856	Guide (roller) for 119-2 Machine, Nos. 1852 and 6441.....
6441	8856	Guide Bracket for 6440.....
7071	8858	Tension Releasing Lever Connection Ex- tension Screw Washer.....
7299	8853	Feed Bar.....
7553	8856	Shuttle Bobbin Case Position Finger for 224841.....
8285	8858	Tension Releasing Lever Hinge Pin.....
8505	6114	Face Plate Thread Guard (lower) Rivet for 2827.....
8505	6114	Face Plate Thread Guard (upper) Rivet for 37307.....
8511	8858	Thread Take-up Spring for 37404.....
8582	6114	Arm Dowel Pin.....
8909	6120	Wrench for 1518 (Accessories).....
10141	6114	Bobbin Winder Tension Spring for 27308
11119	6114	Arm Oil Tube with 29599, for oiling 37343
11204	6112	Thread Take-up Lever Link Hinge Pin..
11241	8860	Arm Top Cover Spool Pin and Thread Eyelet Washer (cloth).....
11241	8860	Bobbin Winder Spool Washer (cloth) for 27308.....
12149	8858	Tension Thread Guard.....
12166	6112	Thread Take-up Lever Hinge Pin for 37345.....
12168	8854	Bobbin Winder Bracket for 12172.....
12169	8859	“ “ Frame for 12171.....

NO.	PLATE	NAME
12170	8859	Bobbin Winder Spring for 12172.....
12171	—	Bobbin Winder Frame complete for 12172, Nos. 333D, 5960, 5961, 5963, 12169 and 15077.....
12172	—	Bobbin Winder complete, Nos. 32D, 180F, 12168, 12170 and 12171.....
12357	8853	Arm Shaft Flanged Bushing (back).....
12388	8853	Oscillating Rock Shaft Hinge Pin for 24105.....
12389	8852	Oscillating Shaft.....
12424	8856	“ “ Crank Slide Block Cap Screw Washer for 19449.....
12454	6114	Arm Oil Tube with 29599, for oiling 37344
12459	6114	Oscillating Rock Shaft Hinge Pin Oil Hole Stop Screw Washer (leather)....
15072	6114	Bobbin Winder Bobbin Position Pin for 15077 and 27538.....
15077	8859	Bobbin Winder Spindle with 15072, for 12171.....
15140	8856	Shuttle Bobbin Case Latch for 15141....
15141	—	Shuttle Bobbin Case Hinge for 224841, Nos. 2973, 2974 and 15140.....
15170	6103	Feed Bar Bell Crank Slide Block for 37348
17542	6104	Lifting Presser Bar Lifter Hinge Pin....
18055	6114	Feeding Foot Hinge Pin for 37358.....
18413	8857	Shuttle Race Ring Spring for 37858, 37871 and 37878.....
19221	6120	Wrench for 1619 (Accessories).....
19448	8856	Oscillating Shaft Crank Slide Block for 19449.....
19449	—	Oscillating Shaft Crank Slide Block com- plete for 37386, Nos. 226D, 988C, 12424 and 19448.....
20197	8853	Crank Connecting Rod with 20198 and two 896E.....
*20198	—	Crank Connecting Rod Cap for 20197...
22372	6103	Feed Bar Guide Bracket Slide Block for 37367.....
24078	8858	Thread Guard (side of arm).....
*24104	8853	Oscillating Rock Shaft for 24105.....
24105	—	Oscillating Rock Shaft complete, Nos. 4784, 12388 and 24104.....
24143	8858	Tension Releasing Lever Spring.....
26026	6120	Screw Driver, machine (Accessories)....
26485	6120	“ “ shuttle tension (Accessories)
27302	8854	Bobbin Winder Frame for 27650.....
27303	6114	“ “ “ Spring for 27650..

NO.	PLATE	NAME
27306	8860	Bobbin Winder Spool Pin for 27308.....
27307	8854	“ “ “ Stand for 27308... ..
27308	8854	Bobbin Winder Spool Stand complete for 27554, Nos. 418e, 1562j, 2106, 10141, 11241, 27306, 27307 and two each 2455 and wood screws 1 in. No. 10.....
27312	8860	Bobbin Winder Stop Latch for 27650.....
27538	8854	“ “ Spindle 27849 with 15072, 27850 and 41828, for 27650.....
27552	8854	Bobbin Winder Base for 27650.....
27553	8854	“ “ Pulley for 27650.....
27554	—	Bobbin Winder (swinging automatic, right hand) complete, Nos. 27308 and 27650
27650	—	Bobbin Winder for 27554, Nos. 35d, 1620j, 27302, 27303, 27312, 27538, 27552, 27553, 50356d and two wood screws 1 in. No. 7.....
27849	—	Bobbin Winder Spindle for 27538.....
*27850	—	“ “ Collar for 27538.....
29505	8853	Arm Top Cover for 29506.....
29506	8853	Arm Top Cover complete, Nos. 29505, 29507 and 29601.....
29507	6114	Arm Top Cover Spool Pin and Thread Eyelet for 29506.....
29599	6114	Arm Oil Tube Packing (felt) for 11119 and 12454.....
29601	6114	Arm Top Cover Spool Pin and Thread Eyelet Washer (steel) for 29506.....
32572	8858	Tension Releasing Disc for 37404.....
32574	8858	“ “ Pin for 37404.....
37023	8853	Lifting Presser Bar (hollow).....
37025	6114	“ “ Spring Pin.....
37303	8853	Arm Shaft Flanged Bushing (front).....
37305	—	Face Plate with 37307, for 37306.....
37306	8854	Face Plate complete, Nos. 2827 and 37305
37307	6114	“ “ Thread Guard (upper) with two 8505, for 37305.....
37310	6103	Feed Bar Bell Crank Cap Screw Washer
37310	6103	Lifting Presser Bar Connecting Link Cap Screw Washer.....
37314	6103	Feed Bar Socket Joint.....
37315	6103	“ “ “ “ Cap.....
37317	6104	“ Regulator Crank with 1813.....
37318	6104	“ “ Lever with 1057d, for 37319.....
37319	—	Feed Regulator Lever 37318 with 330d and 37320.....

NO.	PLATE	NAME
37320	6104	Feed Regulator Lever Clamp for 37319...
37322	6104	“ “ “ Shaft.....
37327	6104	Lifting Presser Bar Connecting Link.....
37328	6104	“ “ “ Lifting Bracket with 453c.....
37329	8855	Lifting Presser Foot (single) for 119-2 Machine.....
*37331	6112	Needle Bar Connecting Link with 794E..
37332	6112	“ “ Stud with 155c, for 37348.....
37333	8853	Needle Bar Crank and Feed Cam with 858c and 1065c.....
37343	6112	Thread Take-up Lever for 37345.....
37344	6112	“ “ “ Link for 37345... ..
37345	—	Thread Take-up Lever complete, Nos. 12166, 37343 and 37344.....
37346	8852	Lifting Lever with 453c, for 37872.....
37348	—	Needle Bar Connecting Stud 37332 with 212d and 15170.....
37351	8858	Thread Take-up Spring Regulator for 37404.....
37356	—	Feeding Foot Plate for 37358.....
37357	—	“ “ Shank for 37358.....
37358	8855	Feeding Foot (hinged) complete for 119-2 Machine, Nos. 18055, 37356 and 37357
*37363	—	Arm.....
37364	6103	Feed Bar Guide Bracket.....
37365	—	“ “ “ “ Cap for 37366..
37366	6103	“ “ “ “ “ 37365 with 37367.....
37367	—	Feed Bar Guide Bracket Slide Block 22372 with 37368, for 37366.....
37368	6103	Feed Bar Guide Bracket Slide Block Stud for 37367.....
37369	8853	Feed Forked Connection.....
37370	6104	“ Regulator Lever Segment.....
*37371	—	Shuttle Driver for 37372.....
37372	8856	“ “ 37371 with two 492c.....
37375	8858	Tension Releasing Lever.....
37377	8852	Arm Shaft.....
37378	6103	Feed Bar Bell Crank.....
37379	6103	“ “ “ “ Bracket with 1497c
37380	6104	Lifting Presser Bar Lifter.....
37385	—	Oscillating Shaft Crank for 37386.....
37386	8856	Oscillating Shaft Crank complete, Nos. 457c, 1518e, 19449 and 37385.....

From the Library of Diamond Needle Corp

NO.	PLATE	NAME
37387	8858	Tension Releasing Lever Connection.....
37388	8858	“ “ “ “ Extension.....
37389	6112	Thread Take-up Crank.....
37390	8860	Lifting Lever Link for 37872.....
37404	—	Tension complete, Nos. 1274c, 1560c, 2103, 8511, 32572, 32574, 37351 and two 2102.....
37408	8853	Lifting Presser Bar Spring.....
*37851	—	Cylinder for 119-2 Machine.....
37852	8855	Needle Plate with 1161D and 37853, for 119-2 Machine.....
37853	8855	Needle Plate Thread Guard for 37852....
37854	8856	Shuttle Body for 37855.....
37855	—	Shuttle, 1 1/4 in. diam., Nos. 2996, 37854 and 224841.....
37856	—	Shuttle Race Body for 37858, obsolete....
37857	—	“ “ Ring for 37858, obsolete....
37858	—	Shuttle Race (flexible) complete for 119-2 Machine, Nos. 37856, 37857 and two each 1289D and 18413, obsolete; use 37878.....
37859	8852	Cloth Plate for 37861.....
37860	8852	“ “ Bracket with 345c, for 37861.....
37861	—	Cloth Plate with Bracket complete for 119-2 Machine, Nos. 37859, 37860 and two 389F.....
Nos. 37862 TO 37865 FOR 119-3 MACHINE		
*37862	—	Cylinder.....
37863	8855	Feeding Foot.....
37864	8855	Lifting Presser Foot.....
37865	8855	“ “ “ for infants' shoes....
37866	8855	Needle Plate (large needle hole) with 1161D and 37868, for 37879.....
37867	—	Needle Plate (small needle hole) with 1161D and 37868, for 37880.....
37868	8855	Needle Plate Thread Guard for 37866, 37867 and 37875.....
37869	—	Shuttle Race Body for 37871.....
37870	—	“ “ Ring for 37871.....
37871	8857	Shuttle Race (flexible) complete for 37879 to 37881, Nos. 37869, 37870 and two each 1289D and 18413.....
37872	—	Foot Lifter complete, Nos. 766D, 802D, 4727, 4885, 6439, 37346 and 37390....

NO.	PLATE	NAME
37873	8855	Feeding Foot, for stitching back strap on ladies' shoes, for 119-3 Machine.....
37874	8855	Lifting Presser Foot, for stitching back strap on ladies' shoes, for 119-3 Machine.....
37875	—	Needle Plate (short needle hole) with 1161D and 37868, for stitching back strap on ladies' shoes, for 37881.....
37876	—	Shuttle Race Body for 37878.....
37877	—	“ “ Ring for 37878.....
37878	8857	Shuttle Race (flexible) complete for 119-2 Machine, Nos. 37876, 37877 and two each 1289D and 18413.....
Nos. 37879 TO 37881 FOR 119-3 MACHINE		
37879	—	Shuttle Race 37871 with 37866 and two 393D.....
37880	—	Shuttle Race 37871 with 37867 and two 393D.....
37881	—	Shuttle Race 37871 with 37875 and two 393D, for stitching back strap on ladies' shoes.....
41828	—	Bobbin Winder Spindle Collar Pin for 27538.....
50356D	8860	Bobbin Winder Frame Hinge Screw for 27650.....
50429C	8858	Thread Retainer Set Screw.....
52454	8858	Thread Retainer.....
56864	8860	Chain Hook (large) for 6439.....
56865	8860	“ “ (small) for 6439.....
120342	6120	Oiler (copper-plated) with 120343 (Accessories).....
120343	6120	Oiler Spout, 3 1/2 in. long, for 120342....
224840	—	Shuttle Bobbin Case for 224841.....
224841	8856	Shuttle Bobbin Case complete for 37855, Nos. 591F, 592E, 2523, 2975, 7553, 15141, 224840 and 224842.....
224842	8856	Shuttle Tension Spring for 224841.....

From the library of Diamond Needle Corp.

ILLUSTRATIONS
OF
PARTS

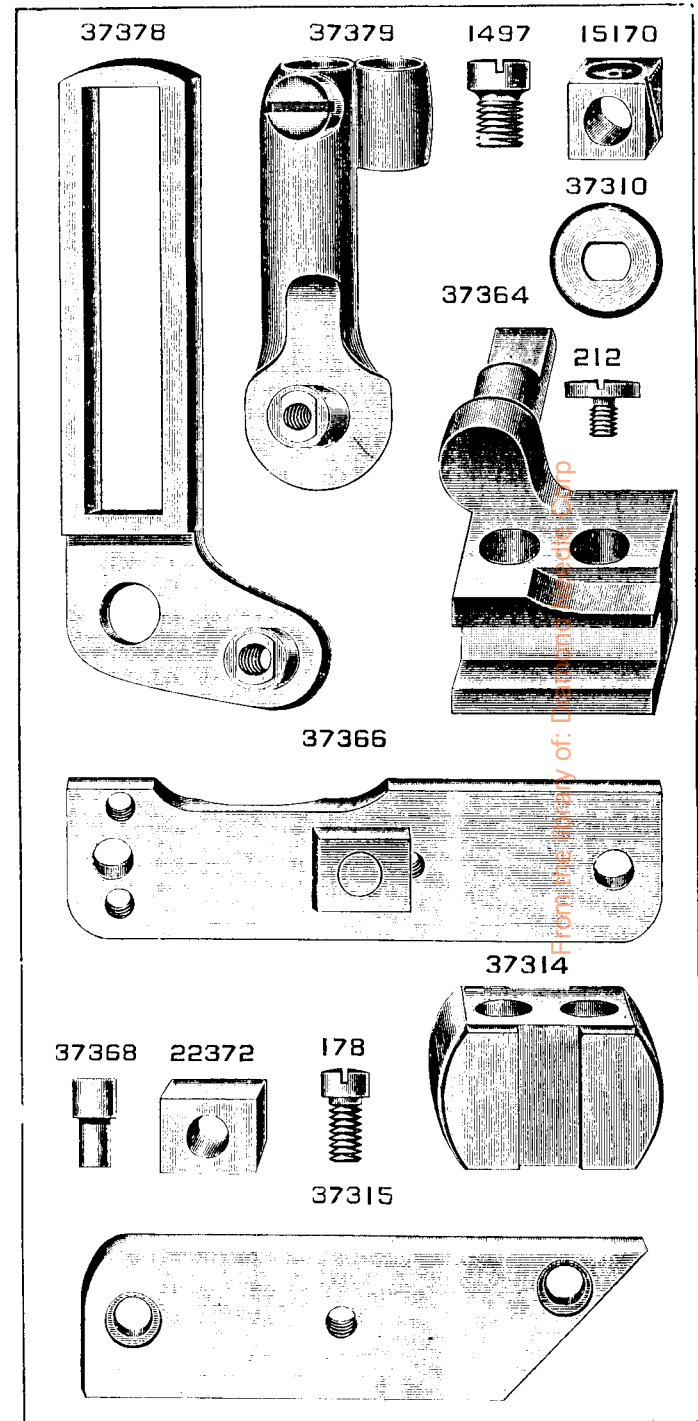


PLATE 6104—FULL SIZE

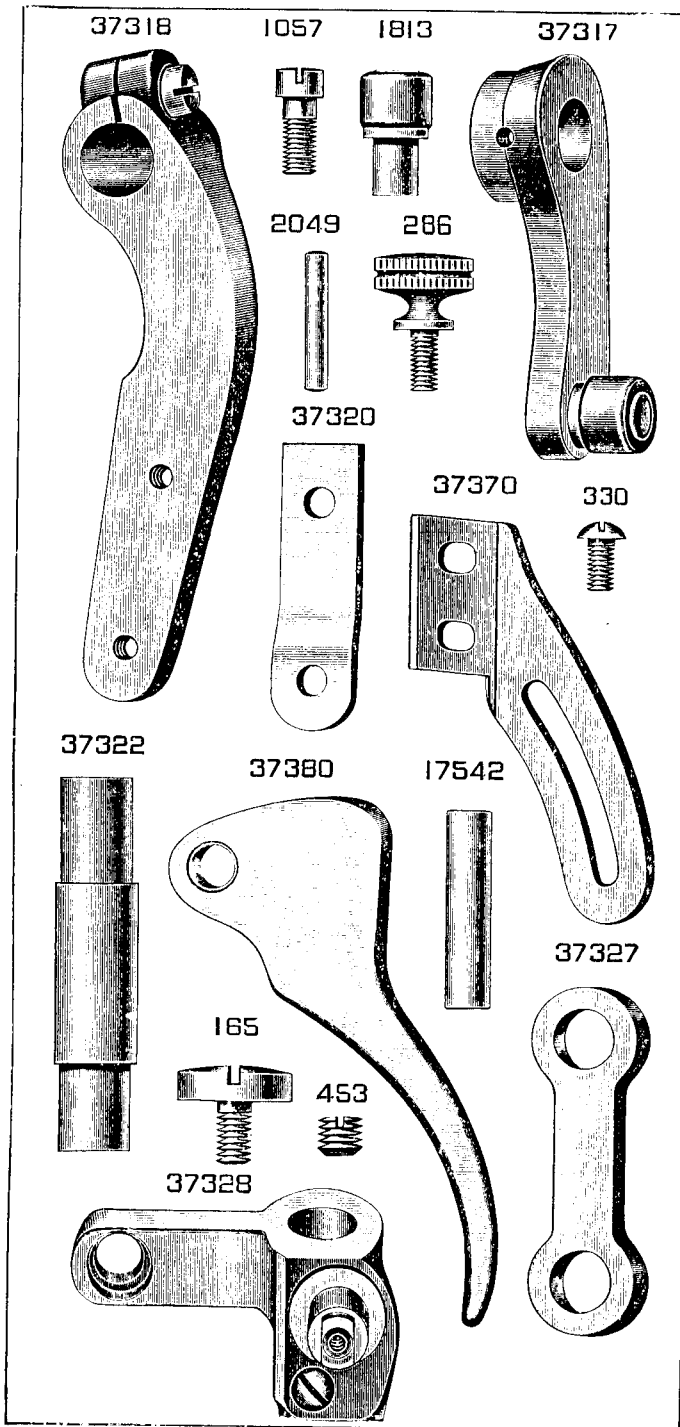


PLATE 6112—FULL SIZE

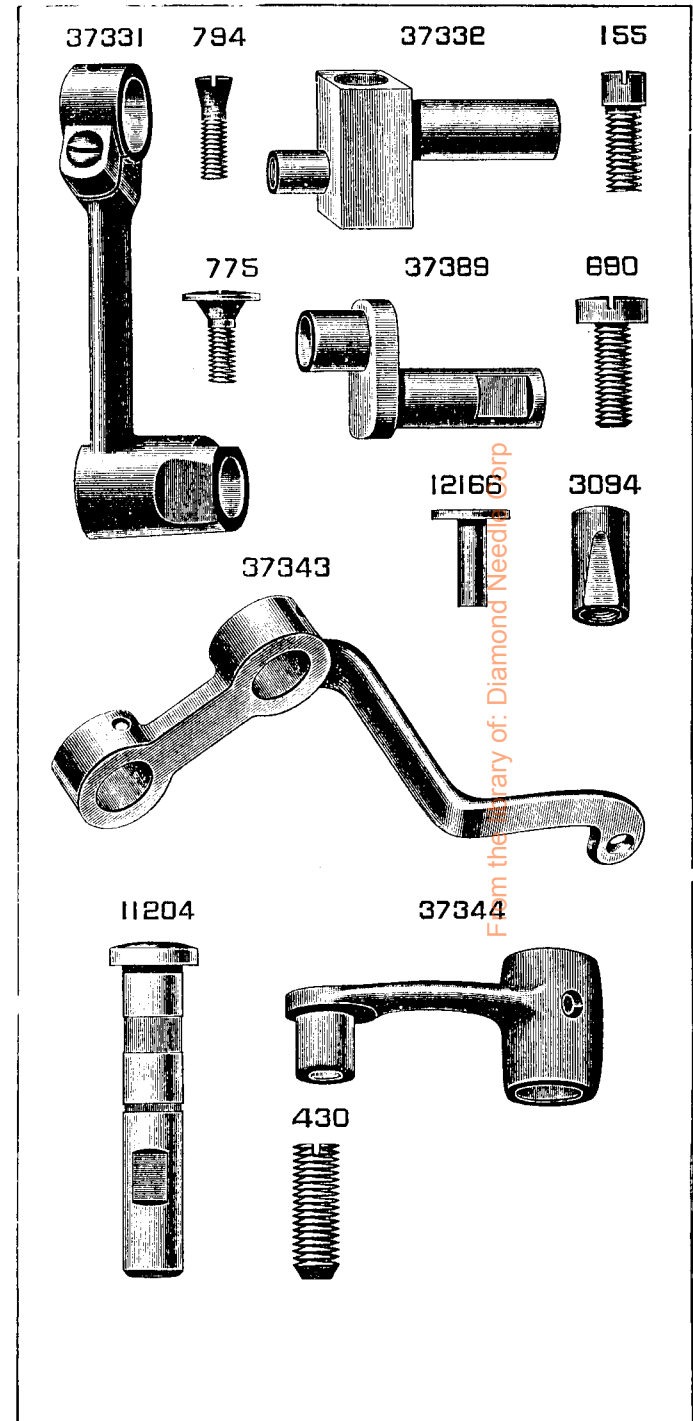
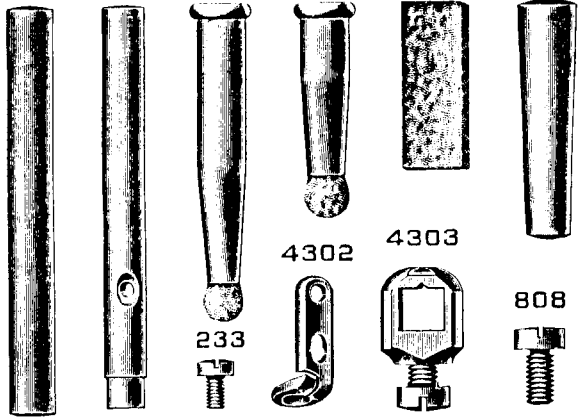
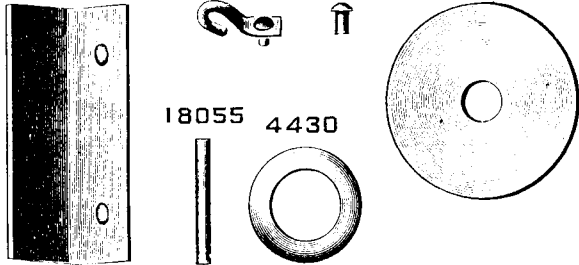


PLATE 6114—FULL SIZE

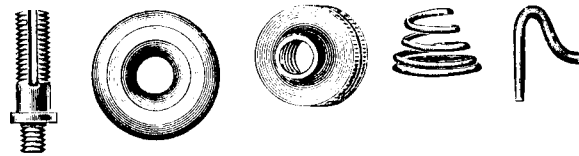
37025 29507 12454 11119 29599 8582



37307 2827 8505 29601



418 2455 1562 10141 2106



12459 15072 27303 4784

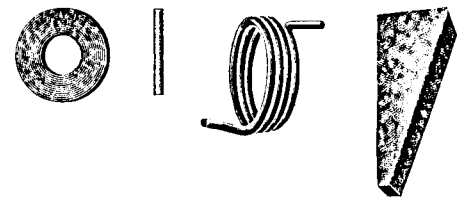
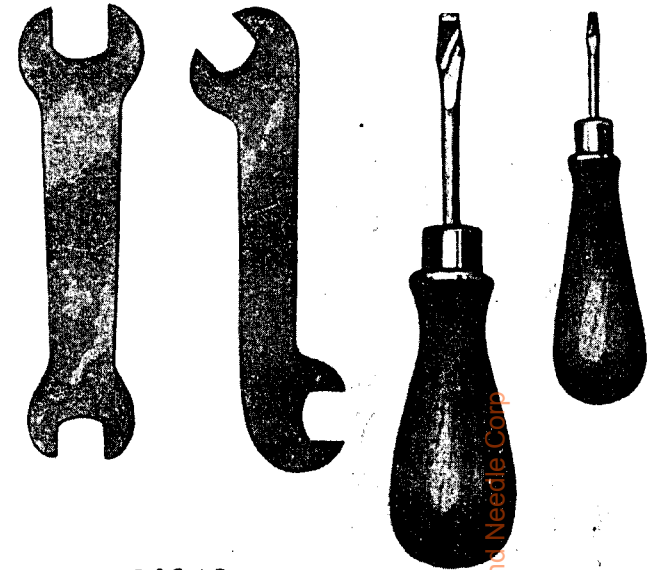
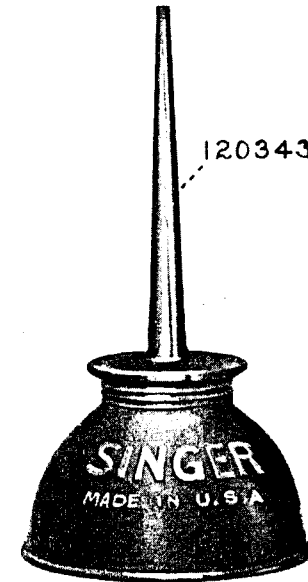


PLATE 6120—ONE-HALF SIZE

8909 19221 26026 26485



120342



41400



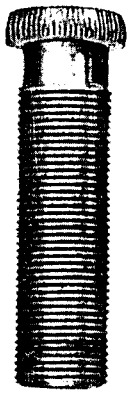
From the library of: Diamond Needle Corp.

PLATE 8851—FULL SIZE

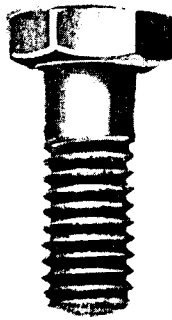
51072



1210



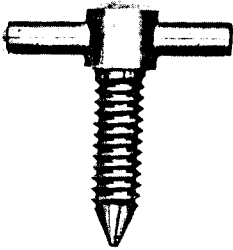
868



116



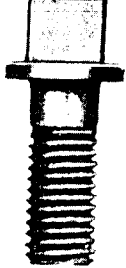
345



802



692



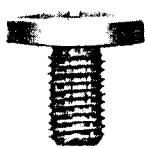
448



908



144



896



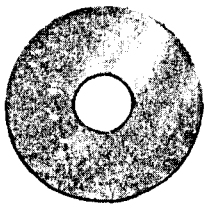
878



190



6055



219



217



79



389



1580



1619



51581

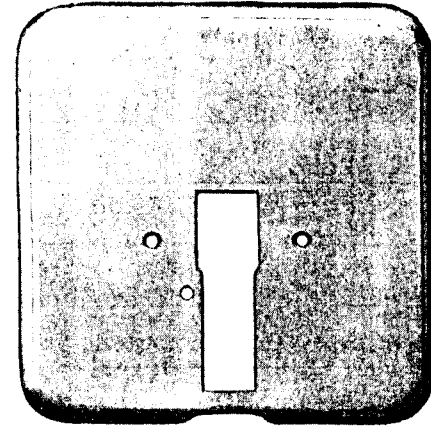


PLATE 8852—ONE-FOURTH SIZE

37377



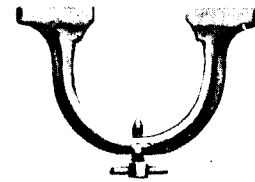
37859



37346



37860



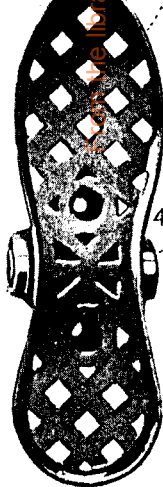
12389



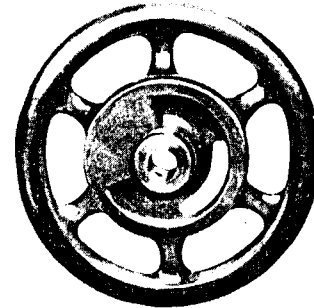
4885



4881



4370

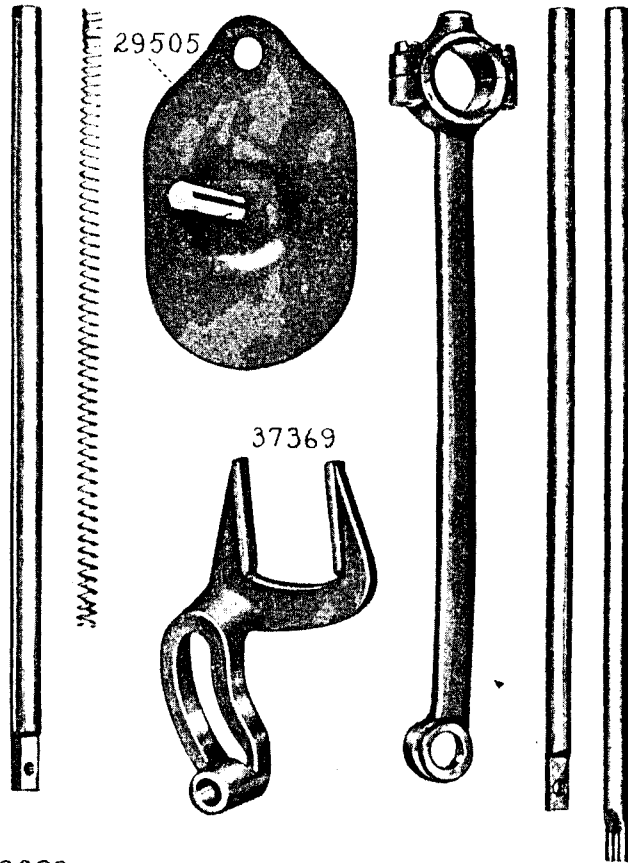


4884



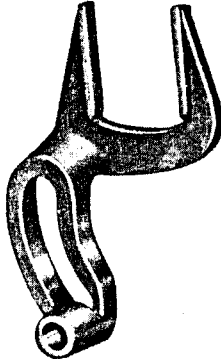
PLATE 8853—ONE-HALF SIZE

37023 37408 29506 20197 7299 5681



29505

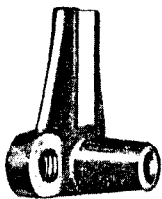
37369



12388



24104



37333



37303

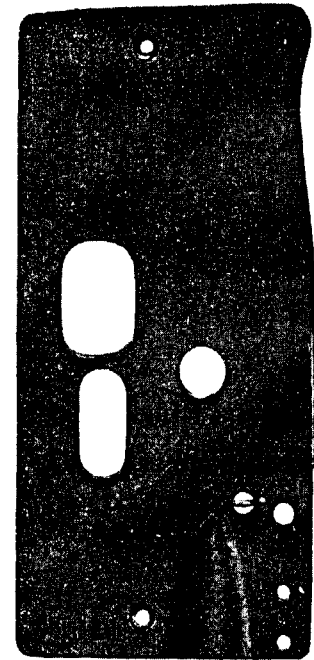


12357

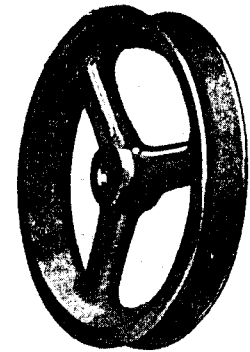


PLATE 8854—ONE-HALF SIZE

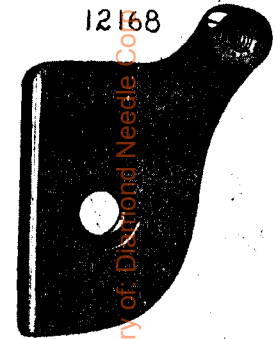
37306



27553



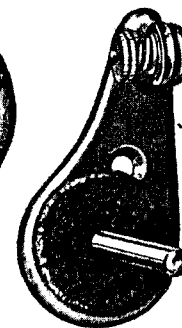
12168



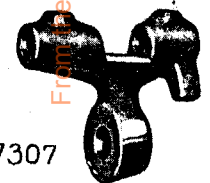
27552



27308

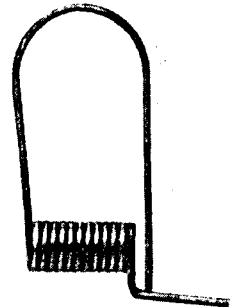


27302

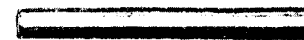


27307

4883



4882



27538



From the library of Dix Iron and Needle Co.

PLATE 8855—FULL SIZE

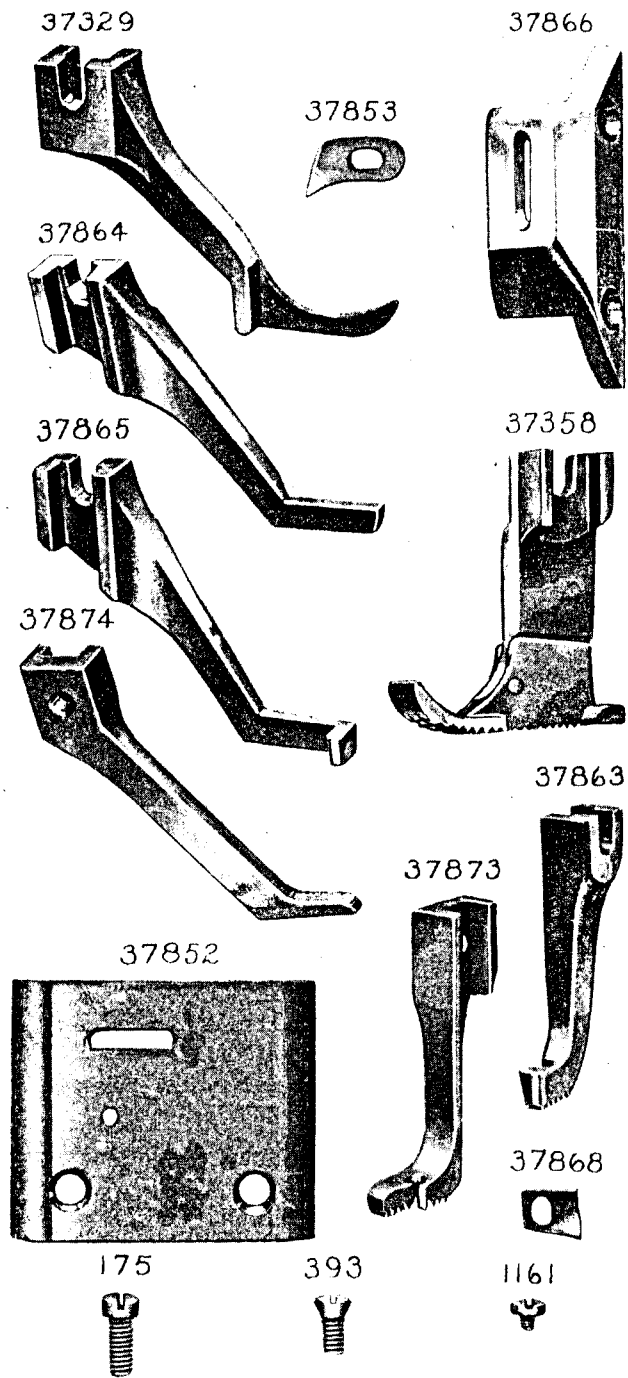
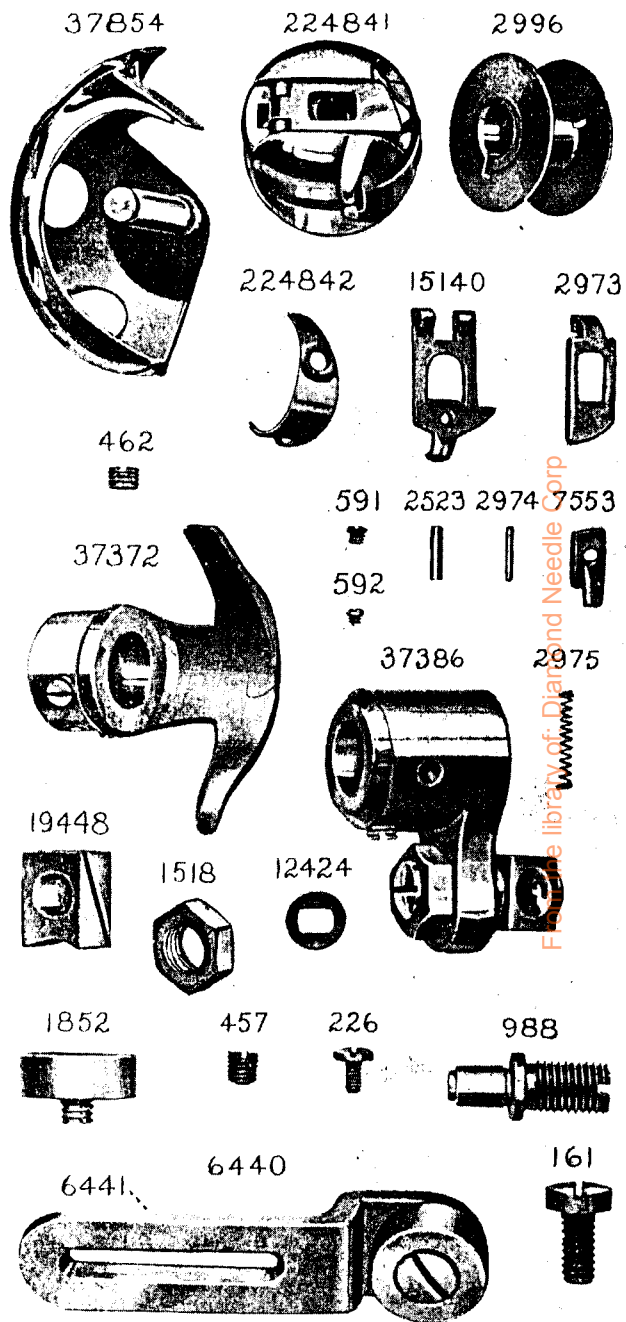


PLATE 8856—FULL SIZE



House Library of: Dians and Needle Corp

PLATE 8857—FULL SIZE

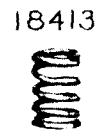
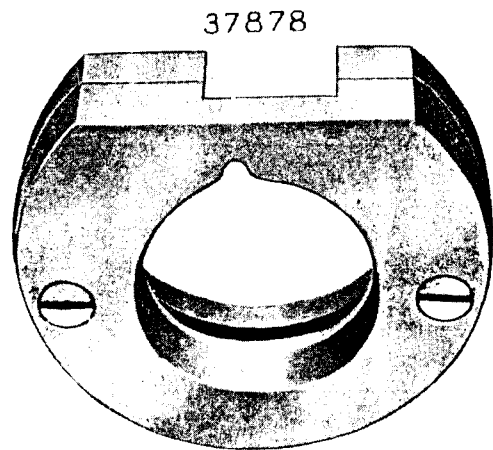
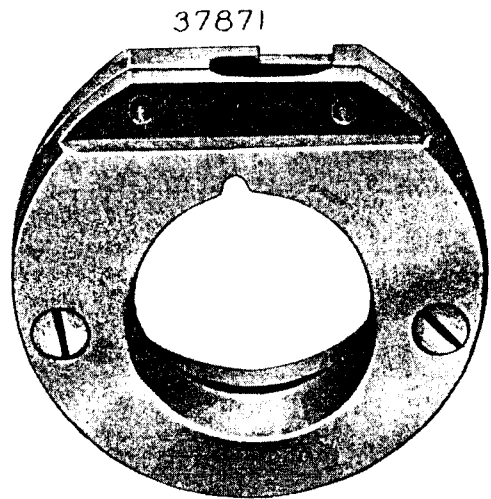
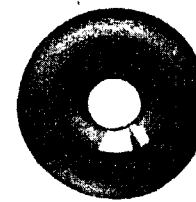


PLATE 8858—FULL SIZE

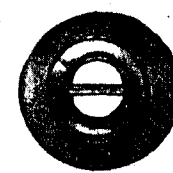
1274



2102



32572



32574



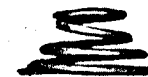
446



1560



2103



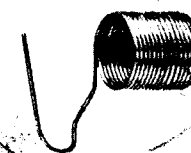
37388



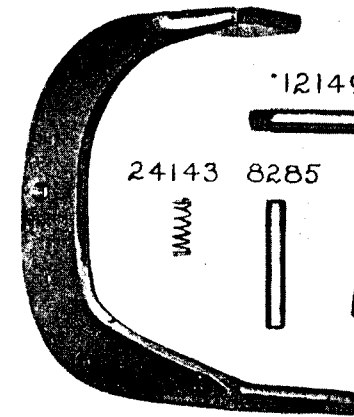
37351



8511



37375



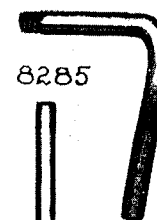
24078



37387



12149



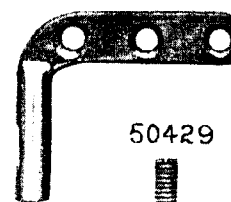
24143



8285



52454



1065



50429



858



7071



From the library of: Diamond Needle Corp

PLATE 8859—FULL SIZE

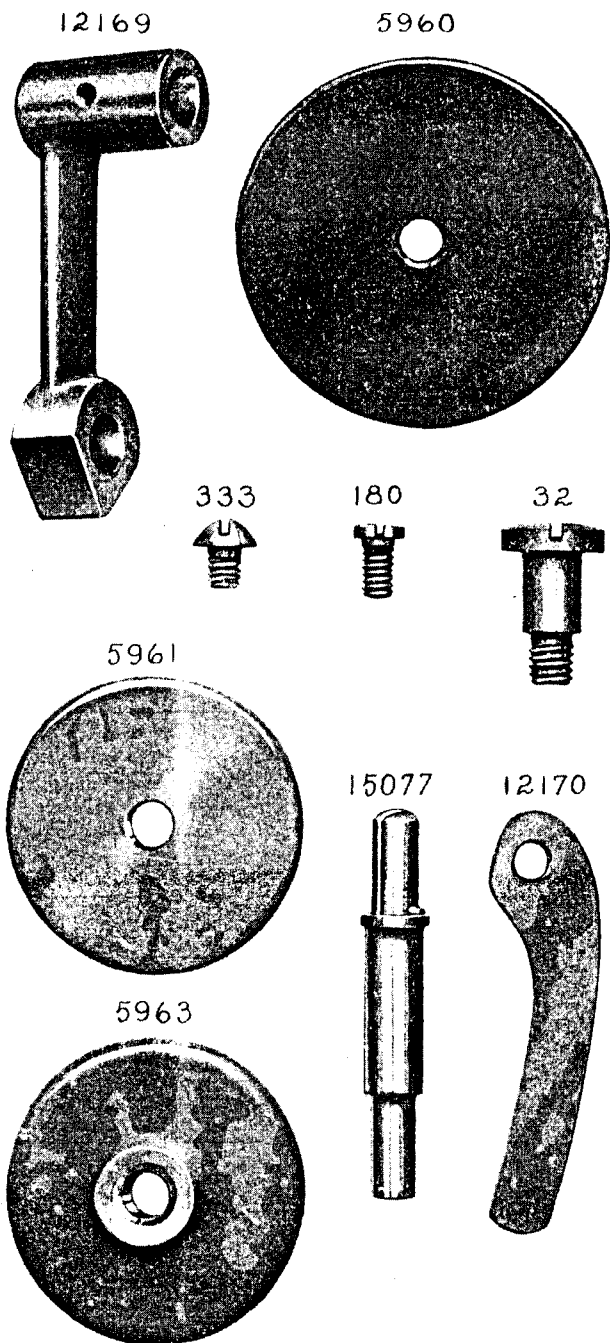
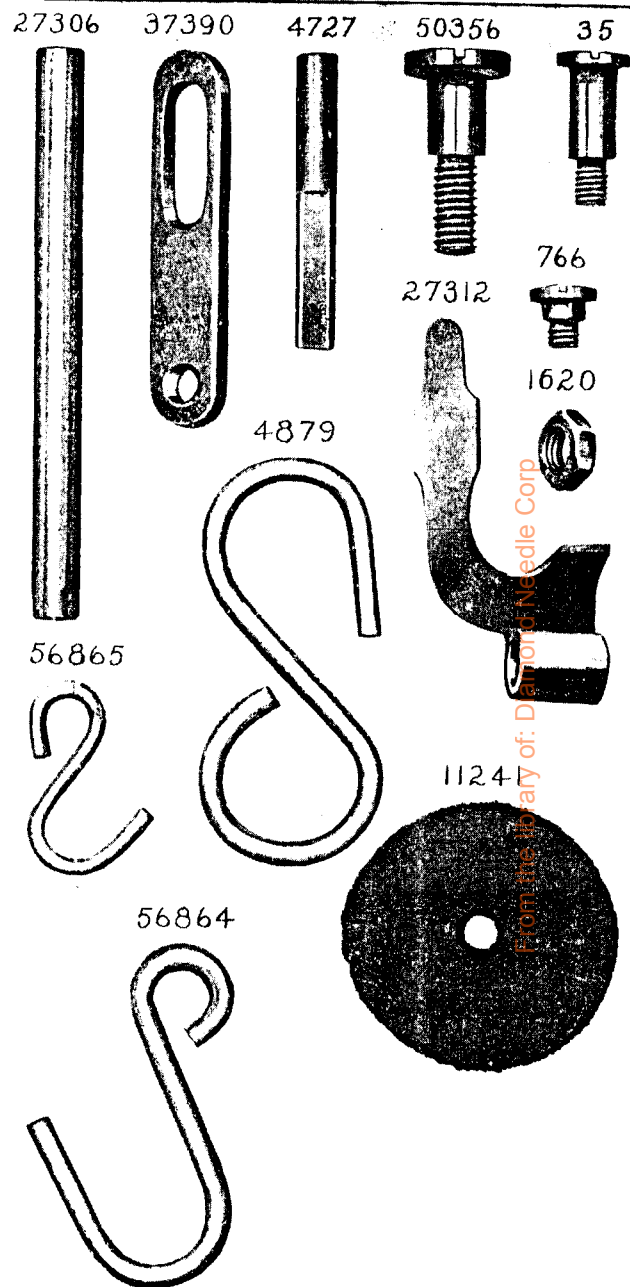


PLATE 8860—FULL SIZE



From the library of: Daimler-Benz AG